



# **Yukon TV User Manual**

Updated November 2021

# WELCOME TO YUKON TV!

Yukon TV is GCI's new TV streaming service that delivers your news, shows, and movies over an internet connection. Yukon TV lets you watch live or on-demand across your TV, tablet, or phone, and continues to offer many of the features of traditional cable box television like Video on Demand, DVR capabilities, channel guides, and more – though there are a few key differences.

Yukon TV:

- Is a streaming application, like Netflix, Hulu, and others
- Is delivered over a GCI internet connection (streaming does not count toward usage)
- Doesn't use a cable box; it uses a streaming device
- Allows you to watch TV on compatible phones, tablets, and TV streaming devices
- Delivers all content in high definition (HD)

## Why Yukon TV?

Change is not always easy, and no one wants another hassle in their daily lives. While we understand this challenge, technology is constantly evolving and we must keep up so that we aren't left behind. Change is underway as cable boxes are being replaced by streaming devices, much like VCRs were replaced by DVD and Blu-ray players, making streaming apps the new, more efficient way to deliver video content. At GCI, we must follow suit with the TV industry and adopt streaming technology to deliver programming. The good news: as we upgrade the technology used to deliver TV services, not only can we continue to provide the best-in-class technology by delivering TV service over an internet connection, but we can also redistribute network resources to support upgraded internet and mobile capabilities, including 5G and 2 gig internet.

## Why does Yukon TV require a GCI internet connection?

Yukon TV requires a connection to GCI's core network, which is the data source behind Yukon TV service. Unlike other streaming apps, streaming Yukon TV at home does not count toward your home internet plan's included high-speed data.

*Stream on, when you stream it on Yukon TV.*

# TABLE OF CONTENTS

## STREAMING DEVICE SELECTION

- 3 Compare Streaming Devices

## YUKON TV ON EVO PRO

- 5 Pre-Installation Checklist
- 6 Installation and Setup
- 7 EVO PRO Remote Control
- 8 Guide Using the Yukon TV App
  - .....Accessing and Navigating the Menu Bar
  - .....Operating the Channel Guide
  - .....Changing Channels
  - .....Turning on Closed Captions
  - .....Setting Recordings

## YUKON TV ON AMAZON FIRE TV CUBE (OR FIRESTICK)

- 11 Pre-Installation Checklist
- 12 Installation and Setup
- 13 Alexa Remote Control Guide
- 18 Using the Yukon TV App

## YUKON TV ON APPLE TV

- 15 Pre-Installation Checklist
- 16 Installation and Setup
- 17 Apple TV Remote Control Guide
- 18 Using the Yukon TV App
  - .....Accessing and Navigating the Menu Bar
  - .....Operating the Channel Guide
  - .....Changing Channels
  - .....Turning on Closed Captions
  - .....Setting Recordings

# STREAMING DEVICE SELECTION

## COMPARE STREAMING DEVICES

You'll need a streaming device to watch Yukon TV on your television.

These devices look and act a lot like a cable box, complete with a remote control. Use the table below to decide which Yukon TV-supported streaming device is the best fit for you.

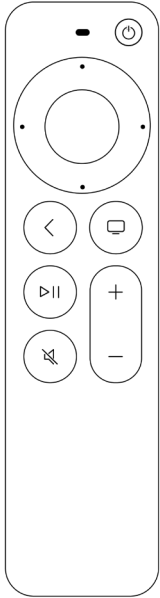
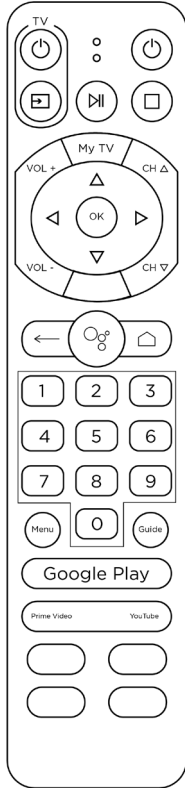
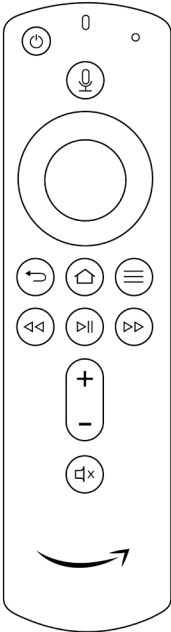
Device	Apple TV	EVO PRO	Amazon Fire TV Cube/Firestick
<b>Best for...</b>	Apple users and tech-savvy viewers who will use their streaming device to access multiple apps.	Traditional TV viewers who want as minimal change as possible to their television-watching experience.  <i>*Device does not support Netflix.</i>	Android and Amazon smart home users who prefer Samsung products and will use their streaming device to access multiple apps.
<b>App Store</b>	Apple Store	Google Play Store	Amazon App Store
<b>Remote - Navigational Design</b>			

Still not sure which device to choose? GCI's free streaming device offer comes with a 14-day exchange period, so you can comfortably swap it out if you change your mind. For a complete list of Yukon TV-supported devices, visit [www.gci.com/yukon-supported-devices](http://www.gci.com/yukon-supported-devices).

**YUKON TV ON EVO PRO**

## PRE-INSTALLATION CHECKLIST

### Before you get started, you'll need:

- Your MyGCI profile username and password
- An active Gmail account
- Home WiFi access, including your network name and password

*Already have these items ready to go? Skip to Installation on page 6.*

### Help with your MyGCI profile username and password

1. Access the internet on your phone, tablet, or computer.
2. Type in the web address in the address bar:
  - a. Create a new account: **[www.my.gci.com/register](http://www.my.gci.com/register)**
  - b. Forgotten username: **[www.my.gci.com/retrieve-username](http://www.my.gci.com/retrieve-username)**
  - c. Forgotten password: **[www.my.gci.com/request-password-reset](http://www.my.gci.com/request-password-reset)**
3. Follow the onscreen instructions.

*Need additional assistance? Call 800-800-4800.*

### Help creating or accessing a Gmail account

1. Access the internet on your phone, tablet, or computer.
2. Type in the web address in the address bar:
  - a. Create a new account: **[www.accounts.google.com/signup](http://www.accounts.google.com/signup)**
    - i. Follow the onscreen instructions.
  - b. Forgotten password: **[www.accounts.google.com/signin](http://www.accounts.google.com/signin)**
    - i. Enter the email address associated with your Google account and click *Next*.
    - ii. On the next screen, select *Forgot password?*
    - iii. Follow the onscreen instructions to reset your password.
  - c. Forgotten email address: **[www.accounts.google.com](http://www.accounts.google.com)**
    - i. Select *Forgot email?*
    - ii. Enter your phone number or recovery email address.

### Help with WiFi access

*For the best experience, we recommend using a GCI-provided WiFi modem.*

Forgotten login information:

1. If you are using a GCI-provided modem and never changed your default login settings, your network name and password information is printed on your modem's label. When prompted, enter this information as your WiFi name and password.
2. If you are using a GCI-provided WiFi modem and *did* change your login settings, call us at 800-800-4800 to have your system reset to factory settings.



## INSTALLATION

### Connect your EVO PRO to your television

You'll need (all items included in EVO PRO box):

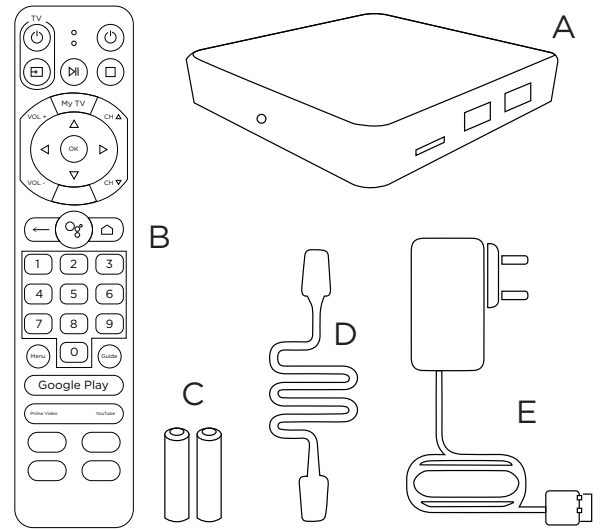
- EVO PRO (A)
- EVO PRO remote control (B)
- 2 AA batteries (C)
- HDMI cord (D)
- Power cord (E)



1. Using the **HDMI cord**, plug one end into your television, and the other end into your **EVO PRO** device.
2. Connect one end of the HDMI cable into the  port of the EVO PRO. Connect the other end into the  port on your TV.
  - a. Remember which  port was used for the device. You'll need that information later during setup.
3. Using the **power cord**, plug the circular end into the port labeled “DC 5V” on the **EVO PRO device**, and plug the other end into an electrical outlet.
4. Insert the **batteries** into your **EVO PRO remote**.
5. Turn on your TV.

## SETUP

### Connect your device to the internet

You will be asked to enter the network name and password of your GCI Home Internet WiFi connection. Follow the onscreen instructions to complete this step.

### Sign into your Google account

You will be asked to sign into your Google-powered EVO PRO device by entering your Google email address and password. Follow the onscreen instructions to complete this step.

### Device setup

You will be asked to enter some information to set up your EVO PRO device. Follow the onscreen instructions, which include:

1. Choose your TV brand:
  - a. Select your TV brand from the list of common brands on the left of the screen or use the *Search* bar to type in your TV brand.
2. Verify Smart RCU (pair your EVO PRO remote to your TV)
  - a. Follow the onscreen instructions to confirm that your television is responding to your remote control's commands.
  - b. When asked to confirm your TV input, be sure the correct HDMI port is selected.



## Download Yukon TV

1. On first use, press the **My TV** button to be brought to the Yukon TV app download screen.
2. Click *Install*.
3. Click *Open*.



**Troubleshooting Tip:** If the app does not download, press the Google Play button on your remote and manually type *Yukon TV* into the search bar. Select the Yukon TV app and click *Install*.

## Sign into Yukon TV

1. Use your MyGCI username and password to sign into Yukon TV.
2. After signing in, you'll be taken to the Yukon TV Home screen.

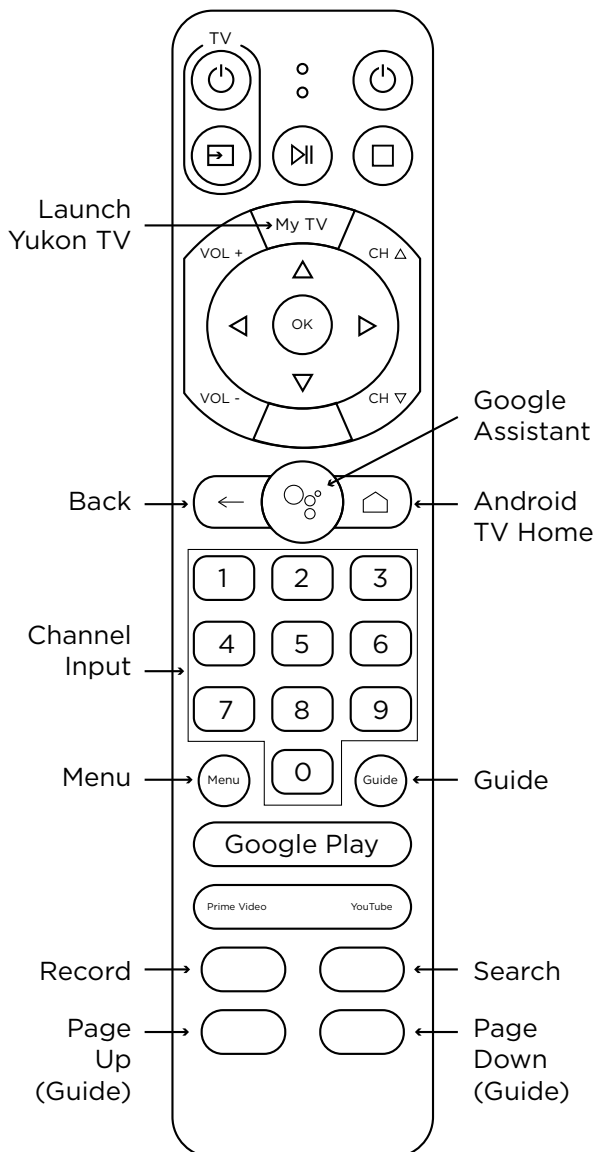

See *page 5* for help signing into MyGCI.



## EVO PRO REMOTE CONTROL GUIDE

### Remote Control Quick Tips:

To quickly launch Yukon TV from any screen, press **My TV**.

The  button on your remote takes you to the EVO PRO home screen, where you can access all apps that have been downloaded to your EVO PRO device. To get back to the Yukon TV Home screen, press **My TV**, then press the  button twice.

Access the Yukon TV menu bar from any screen by pressing the  button.

## USING THE YUKON TV APP ON EVO PRO



### VIDEO TUTORIAL

Scan this code with your phone's camera app to learn how to use Yukon TV on EVO PRO.

### Menu Bar

Press the ← button to pull up the menu bar at the top of the screen, which allows you to perform several other actions:

**Home** - Takes you to the Home screen where you can scroll through suggested content.

**LiveTV** - Resumes live TV on the last channel viewed.

**Guide** - Displays a list of channels and their scheduled programming.

**VOD** (Video on Demand) - Offers a variety of content that can be watched on demand.

**MyDVR** - Stores your recorded shows and movies.

**Search** - A tool to help you quickly find specific content.

 **Settings** - Go here to update your account information.

 **Profile** - Go here to switch between user profiles.



### Channel Guide

#### Using the Guide

1. Press the ← button to pull up the menu bar at the top of the screen.
2. Click **Guide**.
3. To play a program, highlight it and press **OK**.

 **Remote Control Shortcut:** Press the  button on your remote to access the Guide.

#### Browsing the Guide

- To scroll the Guide page by page: use the yellow  button on the bottom left of your remote to scroll page up, and the blue  button on the bottom right of your remote to scroll page down.
- To scroll the Guide by individual channel: use the  buttons on the directional pad.
- To go directly to a specific channel: key in the channel number and either wait 2 seconds, or press **OK**.



 **Remote Control Shortcut:** While watching TV, press the  $\Delta/\nabla$  buttons on the directional pad to bring up an in-screen guide on the left of your screen. Browse and press **OK** to change the channel.

## Changing Channels

Different ways to change the channel:

- Use the  $\Delta/\nabla$  buttons on the directional pad.
- Use the CH  $\Delta$ /CH  $\nabla$  buttons.
- Use the **number buttons** to key in the channel number you wish to watch.
- Select a channel from the **Guide**.
- Press the green  **Search key** to find a specific channel or program.

## Turning on Closed Captions (Subtitles)

1. While watching a show, press the  button to bring up the playback menu.
2. On the right, select the  icon, press **OK**.
3. Choose your Audio settings.
4. Select *CLOSED CAPTIONS*, press **OK**.
5. Select *CLOSE*, press **OK**.

## Setting Recordings

Record a single occurrence:

1. From the Home screen, click **Guide**.
2. Scroll or use the **Search** function to select a show, then press **OK**.
3. Click **Record**. You should now see a red dot next to your show on the guide.

Record a series:

1. From the Home screen, click **Guide**.
2. Scroll or use the **Search** function to select a show, then press **OK**.
3. Click **More Info**. Three options will appear: Watch Now, Restart, and Record.
4. Click **Record**.
5. Choose to record either *This Episode* (single recording), *Next Episodes* (new episodes), or *All Episodes* (old and new episodes).

 **Remote Control Shortcut:** Press the red  button on the bottom left of your remote to access the Record menu from Live TV or the Guide.

## Viewing Recordings

1. Press the  $\leftarrow$  button to pull up the menu bar at the top of the screen.
2. Click **MyDVR**.
3. Select the show you'd like to watch.

For any other questions about Yukon TV, visit  
[www.gci.com/yukon-support](http://www.gci.com/yukon-support)

## YUKON TV ON AMAZON FIRE TV CUBE (OR FIRESTICK)

## PRE-INSTALLATION CHECKLIST

### Before you get started, you'll need:

- Your MyGCI profile username and password
- An active Amazon account
- Home WiFi access, including your network name and password

*Already have these items ready to go? Skip to Installation on page 12.*

### Help with your MyGCI profile username and password

1. Access the internet on your phone, tablet, or computer.
2. Type in the web address in the address bar.
  - a. Create a new account: **www.my.gci.com/register**
  - b. Forgotten username: **www.my.gci.com/retrieve-username**
  - c. Forgotten password: **www.my.gci.com/request-password-reset**
3. Follow the onscreen instructions.

*Need additional assistance? Call 800-800-4800.*

### Help creating or accessing an Amazon account

1. Create a new account:
  - a. Open **www.amazon.com** on the internet on your phone, tablet, or computer.
  - b. Hover over *Hello, Sign in Account & Lists* then under *Sign in*, click ***New customer? Start here.***
  - c. Follow onscreen instructions.
    - i. Note that you will be required to enter payment information to complete setup. Your account is free, the Yukon TV app is free, and you will not be charged unless you make a purchase.
2. Forgotten password:
  - a. Open **www.amazon.com** on the internet on your phone, tablet, or computer.
  - b. Hover over *Hello, Sign in Account & Lists* then click ***Sign in.***
  - c. Click *Forgot your password?*
  - d. Enter your email or mobile phone number and follow onscreen instructions.

### Help with WiFi access

*For the best experience, we recommend using a GCI-provided WiFi modem.*

Forgotten login information:

1. If you are using a GCI-provided modem and never changed your default login settings, your network name and password information is printed on your modem's label. When prompted, enter this information as your WiFi name and password.
2. If you are using a GCI-provided WiFi modem and *did* change your login settings, call us at 800-800-4800 to have your system reset to factory settings.





## INSTALLATION

### Connect your Fire TV Cube to your television

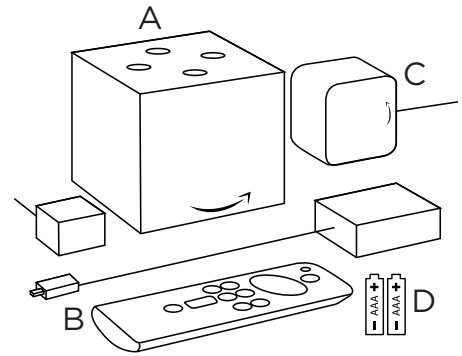
You'll need:

- Fire TV Cube (A)
- Alexa Voice Remote (B)
- Power cord (C)
- 2 AAA batteries (D)
- HDMI cable (not included)



1. Place your Fire TV Cube 1 to 2 ft. away from any speakers.
2. Connect one end of the HDMI cable (not included) into the  port of the Fire TV Cube. Connect the other end into the  port on your TV.
  - a. Remember which  port was used for the device. You'll need that information later during setup.
3. Plug the power cord into your Fire TV Cube and then into a power outlet.
4. Put batteries in your Alexa Voice remote.
5. Turn on your TV and switch to the correct HDMI input.
  - a. If your remote doesn't pair automatically, press the  button until "Press  to start" appears onscreen (about 10 seconds).

## SETUP

### Connect your device to the internet

Follow the onscreen instructions to connect to WiFi and download the latest software update.



### Sign into your Amazon account

You will be asked to sign into your Amazon device by entering your Amazon login information. Follow the onscreen prompts to complete this step. You will need your mobile phone or computer to visit the onscreen web address ([www.amazon.com/code](http://www.amazon.com/code)) and enter the verification code.

### Device setup

After signing into your Amazon account and entering the verification code, follow the onscreen instructions to set up equipment control for devices like soundbars.

### Download Yukon TV

1. Click *Find* from the device's home screen menu.
2. Click *App Store*.
3. From the page menu, click *Search*.
4. Type in "Yukon TV" and search.
5. Select Yukon TV.
6. Click *Get*  or the *Shopping Cart*  icon to start your download.

## Sign into Yukon TV

1. Use your MyGCI username and password to sign into Yukon TV.
2. After signing in, you'll be taken to the Yukon TV Home screen.

See *page 11* for help signing into MyGCI.

## USING THE YUKON TV APP ON AMAZON DEVICES

*Jump to page 18.*

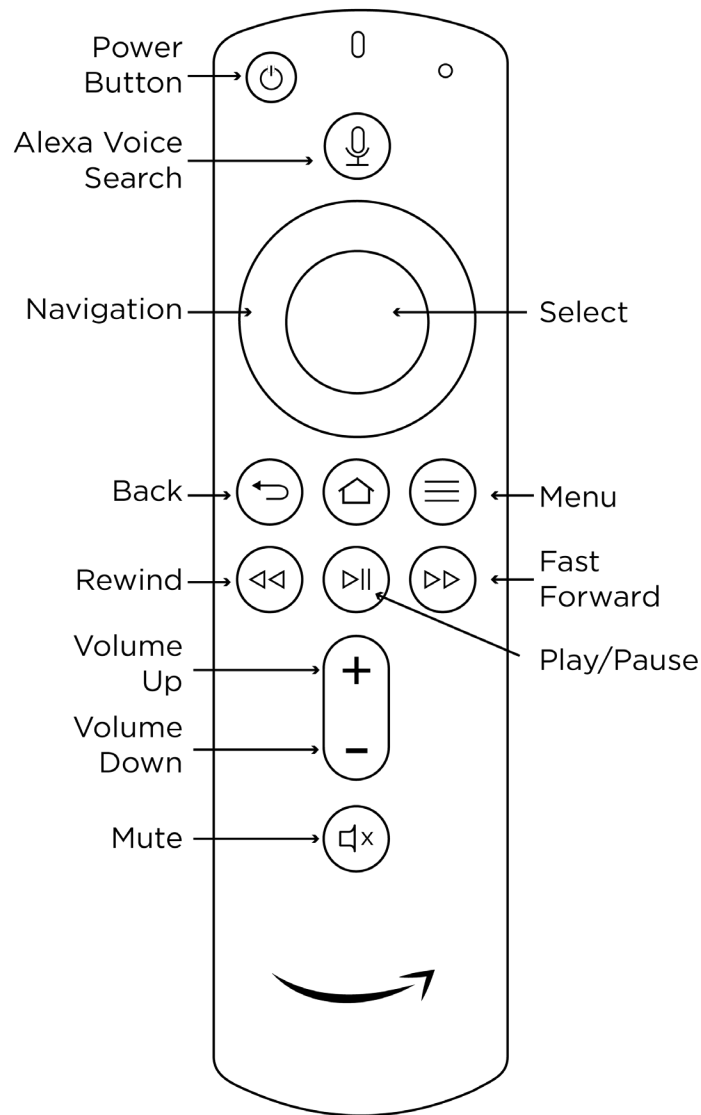

## AMAZON REMOTE CONTROL GUIDE

### Remote Control Quick Tips:

Hold the  button to force quit the app.

While using the Yukon TV app, access the Yukon TV menu bar from any screen by pressing the  button.

The  button takes you to Amazon device's home screen, where you can access all apps that have been downloaded to device. To get back to Yukon TV, select the Yukon TV app from your device's app library.

## YUKON TV ON APPLE TV



## PRE-INSTALLATION CHECKLIST

### Before you get started, you'll need:

- Your MyGCI profile username and password
- An active Apple account
- Home WiFi access, including your network name and password

*Already have these items ready to go? Skip to Installation on page 16.*

### Help with your MyGCI profile username and password

1. Access the internet on your phone, tablet, or computer.
2. Type in the web address in the address bar:
  - a. Create a new account: [www.my.gci.com/register](http://www.my.gci.com/register)
  - b. Forgotten username: [www.my.gci.com/retrieve-username](http://www.my.gci.com/retrieve-username)
  - c. Forgotten password: [www.my.gci.com/request-password-reset](http://www.my.gci.com/request-password-reset)
3. Follow the onscreen instructions.

*Need additional assistance? Call 800-800-4800.*

### Help creating or accessing your Apple ID

1. Create a new account:
  - a. When you set up your Apple TV and are asked for your Apple ID, click *"Forgot password or don't have an Apple ID?"*
  - b. Click *"Create a Free Apple ID."*
  - c. Follow onscreen instructions.
    - i. Note that you will be required to enter payment information to complete setup. Your account is free, the Yukon TV app is free, and you will not be charged unless you make a purchase.
2. Forgotten password:
  - a. When you set up your Apple TV and are asked for your Apple ID, click *"Forgot password or don't have an Apple ID?"*
  - b. Click *"Forgot password."*
  - c. Follow the onscreen instructions.

### Help with WiFi access

*For the best experience, we recommend using a GCI-provided WiFi modem.*

#### Forgotten login information:

1. If you are using a GCI-provided modem and never changed your default login settings, your network name and password information is printed on your modem's label. When prompted, enter this information as your WiFi name and password.
2. If you are using a GCI-provided WiFi modem and *did* change your login settings, call us at 800-800-4800 to have your system reset to factory settings.



## INSTALLATION

### How to connect your Apple TV to your television

You'll need:

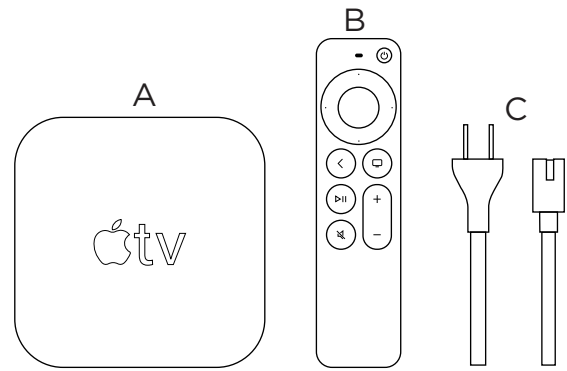
- Apple TV (A)
- Apple TV remote (B)
- Power cord (C)
- HDMI cable (not included)



1. Connect one end of the HDMI cable (not included) into the  port of your Apple TV. Connect the other end into the  port on your TV.
  - a. Remember which  port was used for the device. You'll need that information later during setup.
2. Plug the power cord into your Apple TV and then into a power outlet.
3. Turn on your TV and switch to the correct HDMI input.

## SETUP

### WiFi access and Apple ID login

To use your iPhone or iPad to automatically add your Apple ID and WiFi settings to your Apple TV, choose **Set Up with Device**. Then unlock your iPhone or iPad, hold it next to your Apple TV, and follow the onscreen steps on your handheld device and Apple TV.

If you don't want to set up your Apple TV with your iPhone or iPad, choose **Set Up Manually**. Then follow the onscreen steps on your Apple TV to connect to your home WiFi network and sign in with your Apple ID.

### Device setup

After signing in with your Apple ID, follow the onscreen instructions to set up equipment.

### Download Yukon TV

1. Select the App Store app from your app library.
2. Search "Yukon TV."
3. Click *Get*.

### Sign into Yukon TV

1. Use your MyGCI username and password to sign into Yukon TV.
2. After signing in, you'll be taken to the Yukon TV Home screen.

See *page 15* for help signing into MyGCI.

## APPLE TV REMOTE CONTROL GUIDE

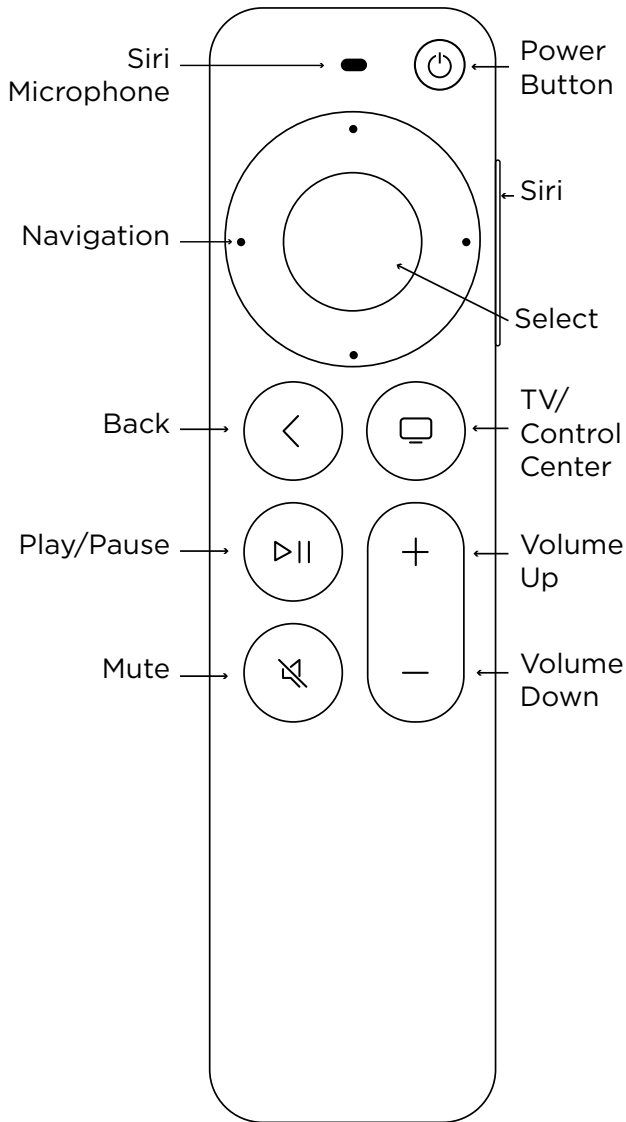

### Remote Control Quick Tips:

Double tap the  button to force quit the app.

While using the Yukon TV app, access the Yukon TV menu bar from any screen by pressing the  button (depending on your Apple TV model).

The  button on your remote takes you to the Apple TV home screen, where you can access all apps that have been downloaded to your streaming device. To get back to Yukon TV, select the Yukon TV app.

## USING THE YUKON TV APP ON AMAZON AND APPLE TV DEVICES



### APPLE TV VIDEO TUTORIAL

Scan this code with your phone's camera app to learn how to use Yukon TV on Apple TV.



### AMAZON FIRE VIDEO TUTORIAL

Scan this code with your phone's camera app to learn how to use Yukon TV on Amazon Fire devices.

### Menu Bar

Press the or button to pull up the menu bar at the top of the screen, which allows you to perform several other actions:

**Home** - Takes you to the Home screen where you can scroll through suggested content.

**LiveTV** - Resumes live TV on the last channel viewed.

**Guide** - Displays a list of channels and their scheduled programming.

**VOD (Video on Demand)** - Offers a variety of content that can be watched on demand.

**MyDVR** - Stores your recorded shows and movies.

**Search** - A tool to help you quickly find specific content.

**Settings** - Go here to update your account information.

**Profile** - Go here to switch between user profiles.

### Channel Guide

#### Using the Guide

1. Press or to open the top menu bar.
2. Click **Guide**.
3. To play a program, highlight it and press the button.

#### Browsing the Guide

You can scroll the guide by individual channel by using the / buttons on the directional pad. Long-press to scroll quickly; tap to scroll one channel at a time.





**Remote Control Shortcut:** While watching TV, press the / buttons on the directional pad, or tap your trackpad to bring up an in-screen guide on the left of your screen. Browse and press the button to change the channel.

## Changing Channels

Different ways to change the channel:

1. Use the  button on the directional pad.
2. Select a channel from the **Guide**.

## Turning on Closed Captions (Subtitles)

1. While watching a show, press the  button to bring up the playback menu.
2. On the right, select the  icon, press the  button.
3. Choose your Audio settings.
4. Select *CLOSED CAPTIONS*, press the  button.
5. Select *CLOSE*, press the .

## Setting Recordings





Record a single occurrence:

1. From the Home screen, click **Guide**.
2. Scroll or use the **Search** function to select a show, then press the  button.
3. Click **Record**. You should now see a red dot next to your show on the Guide.

Record a series:

1. From the Home screen, click **Guide**.
2. Scroll or use the **Search** function to select a show, then press the  button.
3. Click **More Info**. Three options will appear: Watch Now, Restart, and Record.
4. Click **Record**.
5. Choose to record either *This Episode* (single recording), *Next Episodes* (new episodes), or *All Episodes* (old and new episodes).

## Viewing Recordings:

1. Press the menu icon / or back icon / button to pull up the menu bar at the top of the screen.
2. Click **MyDVR**.
3. Select the show you'd like to watch.

For any other questions about Yukon TV, visit  
[www.gci.com/yukon-support](http://www.gci.com/yukon-support)